

QUICK START ULTIMATE+



MOUNT YOUR PEDALS

Mount the pedals with the flanged M6 bolts (Torx 25) onto our Heusinkveld Ultimate+ Baseplate or a very rigid base. Longer bolts are included for different thickness pedal plates (1).

Adjust the pedal position and pedal angle for optimal ergonomics (2).

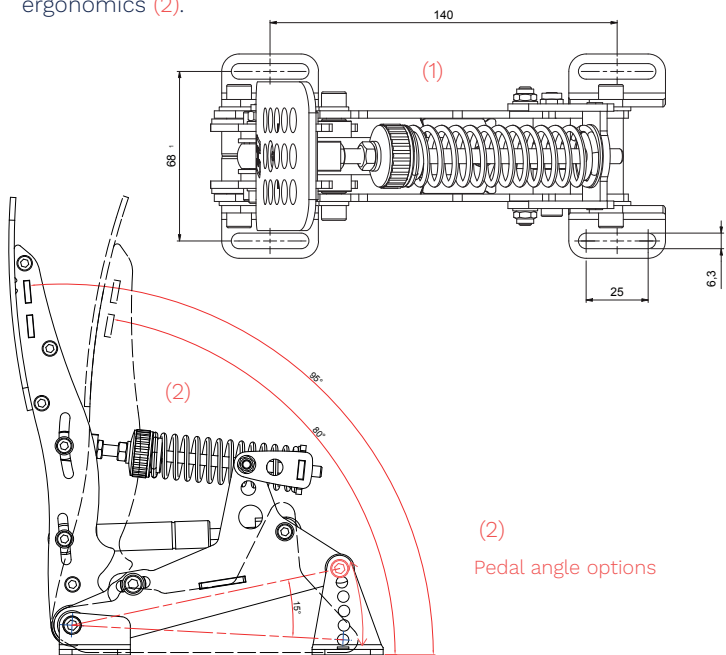

CONNECT YOUR PEDALS

Plug each pedal into the corresponding port of the controller box (the small box with the metal enclosure). If you have a 2-pedal set, you can leave the clutch port empty.

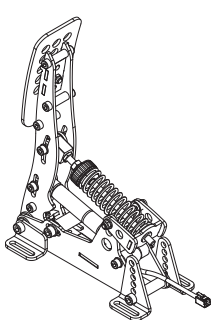

THROTTLE

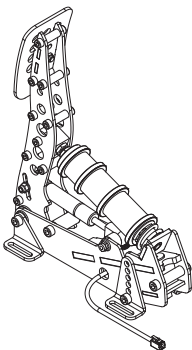

BRAKE

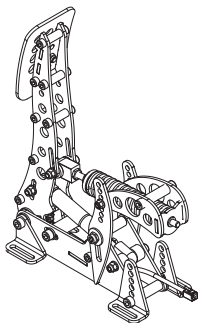

CLUTCH

Connect the provided USB-cable between the controller box and your PC (3). The pedals are pre-calibrated and will work after assigning them in your favourite simulator software.

USB-port

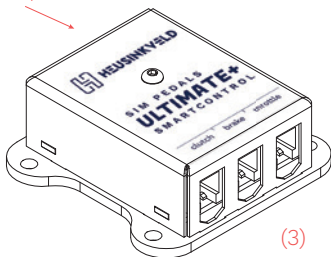

(3)

You are ready to race.

ADJUSTMENTS

Your Ultimate+ pedals have numerous adjustments which allow you to set up the pedals to your personal preferences, such as:

All pedals:

- Pedal angle
- Pedal plate height
- Hydraulic damper resistance

Throttle & Clutch:

- Pedal travel
- Overall pedal force
- Pedal spring preload

Clutch only:

- Pedal force curve

Brake only:

- A total of 9 resistance settings

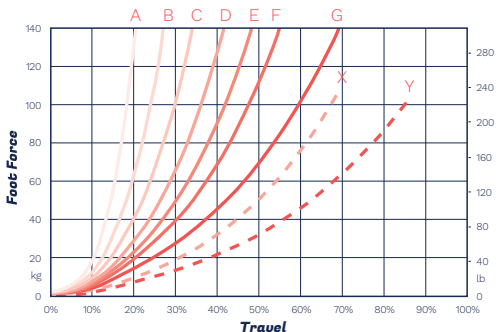

Possible brake curve settings

Check the extra information on our website on how to make these adjustments.

SMARTCONTROL & SMARTCONTROL LIVE

Heusinkveld® simracing products come with powerful software tools. Download SmartControl and SmartControl Live from our website heusinkveld.com/overview-smartcontrol-live

With SmartControl you can configure (non-linear) pedal output curves, set pedal deadzones and brake pedal force and save your settings to an unlimited number of profiles.

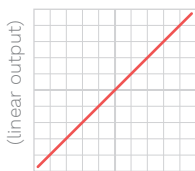

(input)

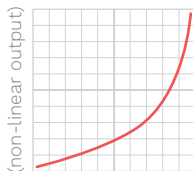

(input)

With **SmartControl LIVE** you can activate your settings on the go. Change settings and apply your profiles while driving.



Read more about it

HEUSINKVELD®

EXTRA INFORMATION & TUTORIALS

This is the Quick Start manual for your Heusinkveld Ultimate+ pedals. It contains all essential information to start using your Ultimate+ pedals. Extra information, tutorials and the SmartControl software can be found on our website:

heusinkveld.com/support/product-manuals



PIT STOP FOR YOUR QUESTIONS

If you have any questions about our products or need help with the installation, our Support Team is happy to help you at support@heusinkveld.com

JOIN OUR COMMUNITY



PLEASE RECYCLE RESPONSIBLY

The packaging of this product is made out of paper and cardboard where possible. Please make sure to follow local guidelines for responsible recycling.



This product is CE Certified:
heusinkveld.com/ce-certifications